

4

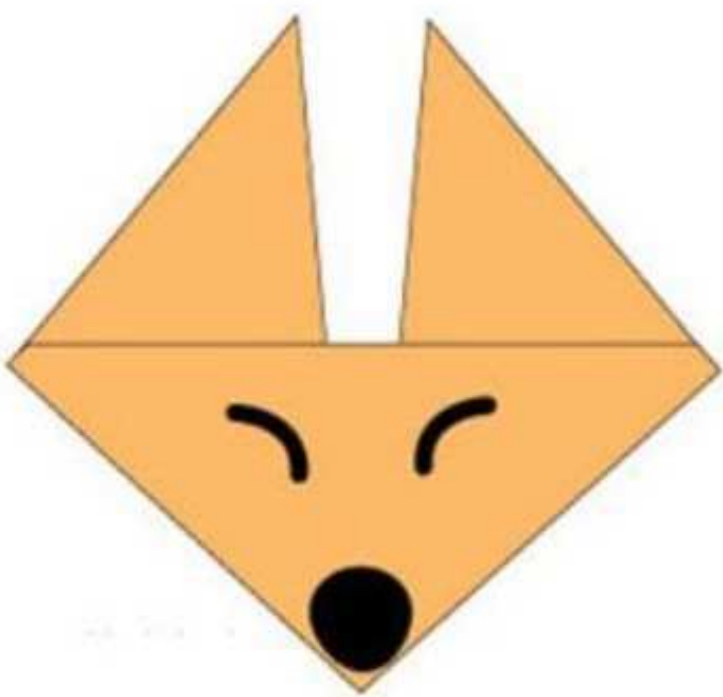

3

5

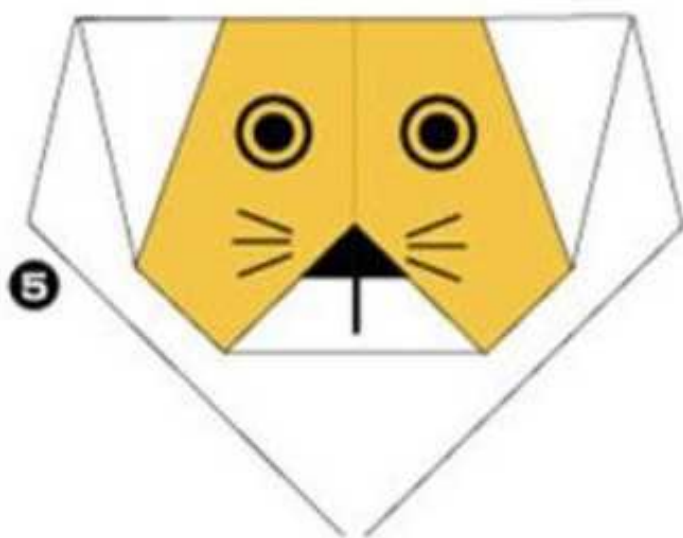
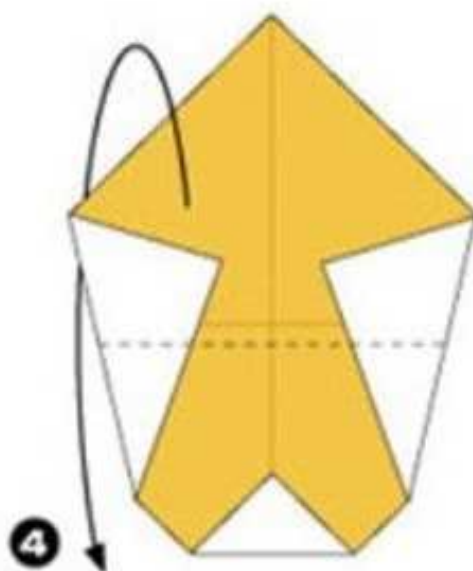
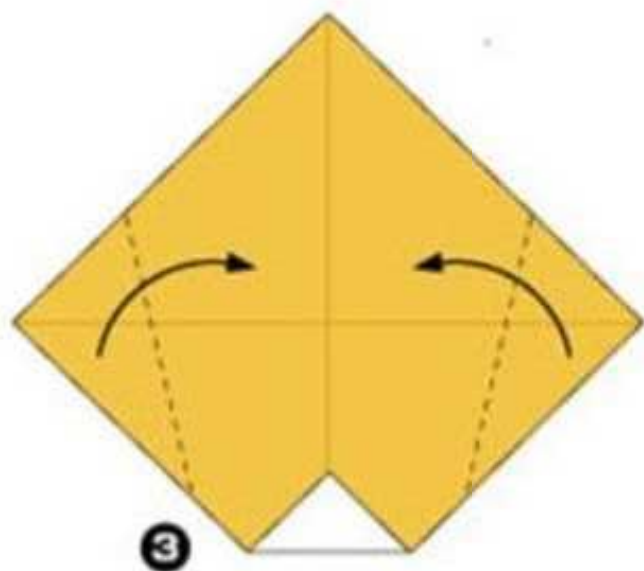
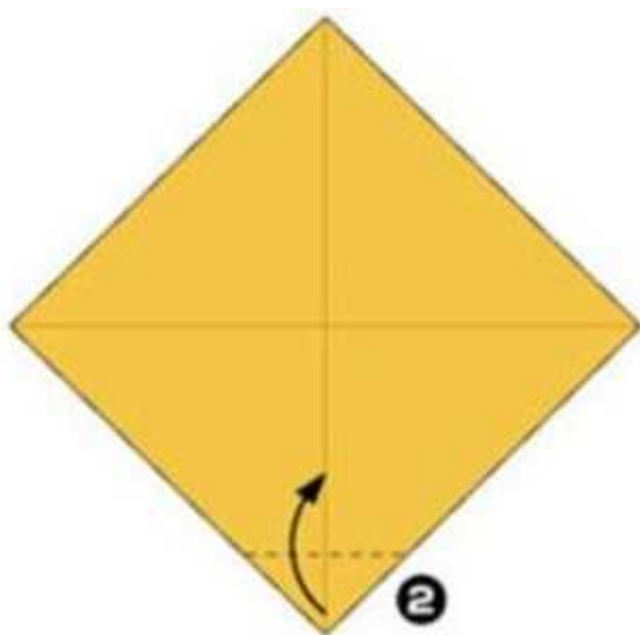
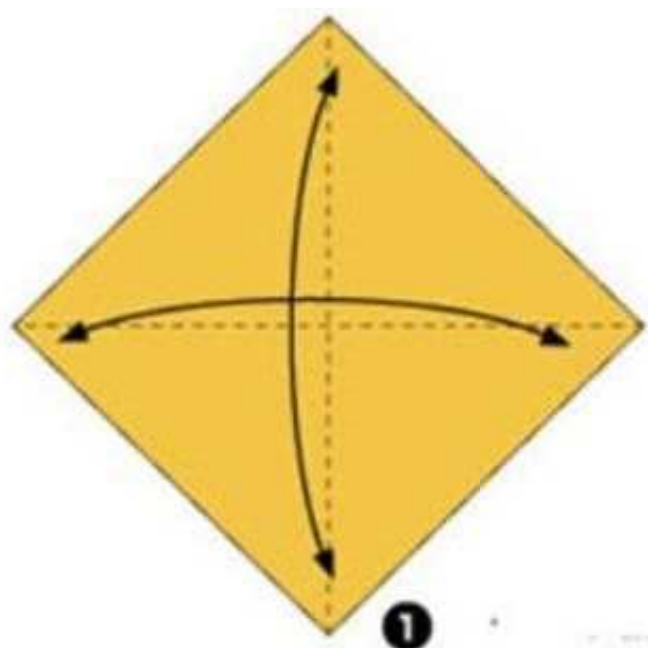

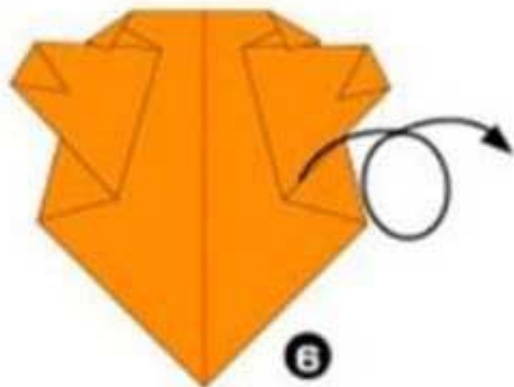
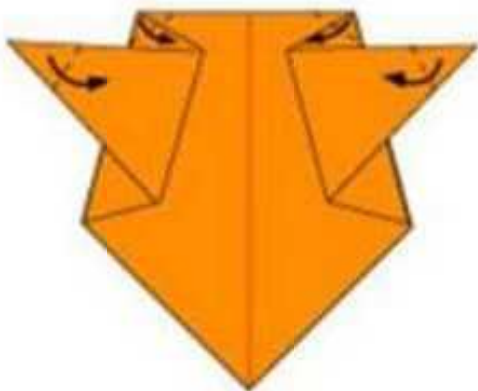
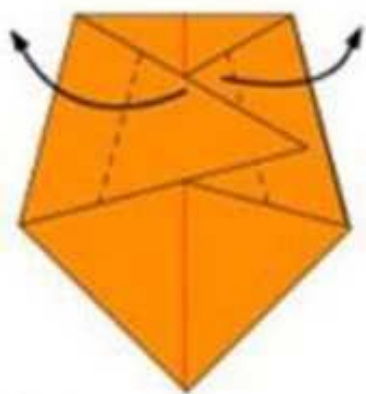
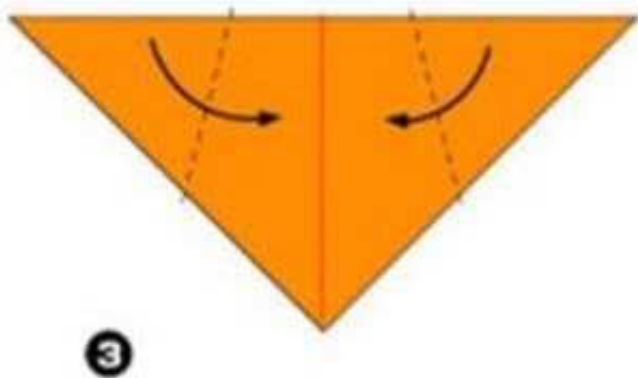
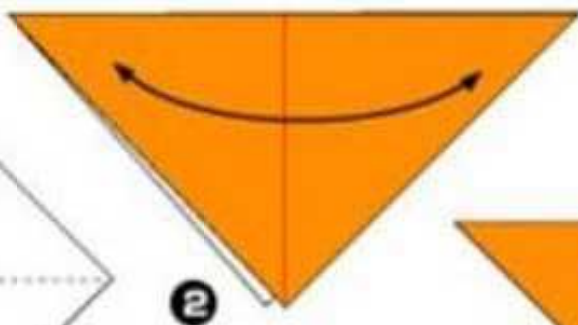
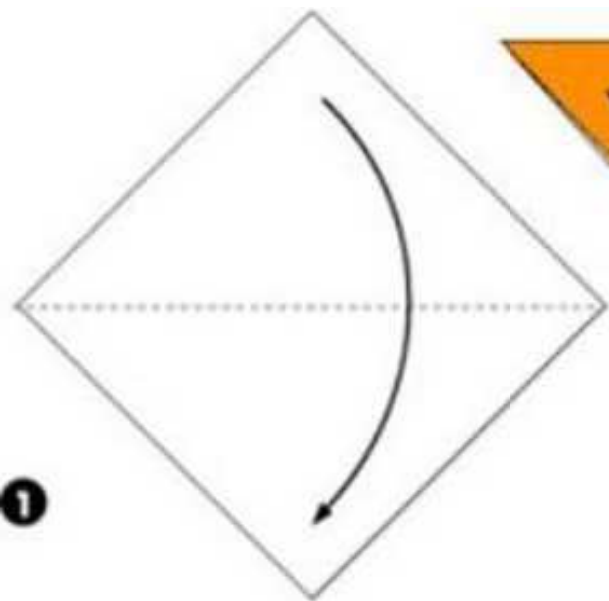

4

5

6

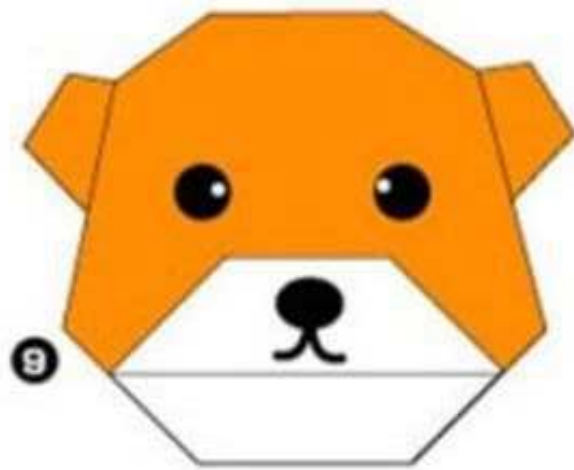
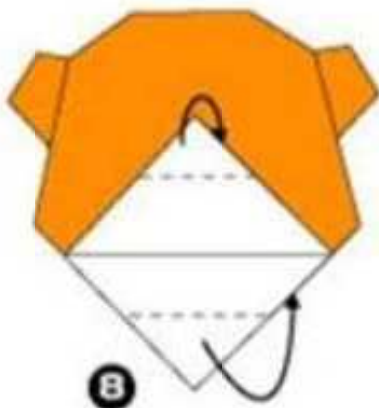
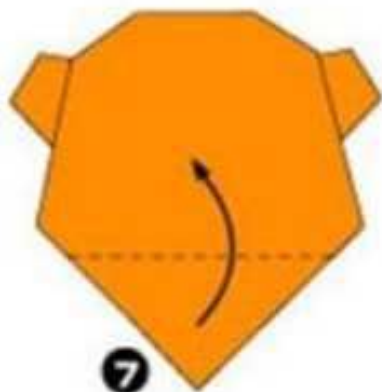

7

8

9

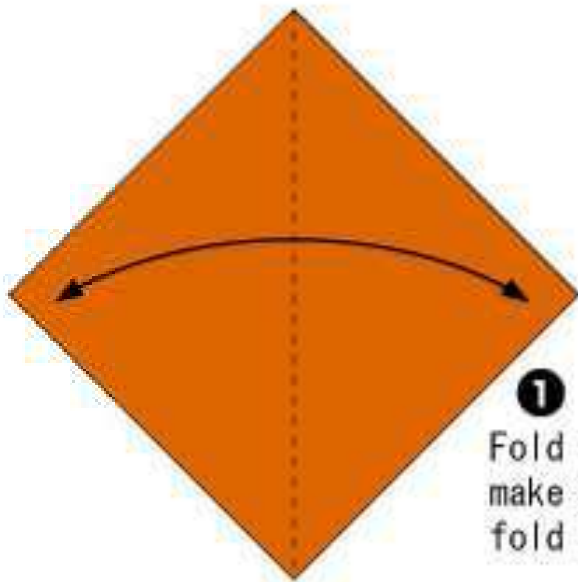

1
Fold in half to
make a crease and
fold back

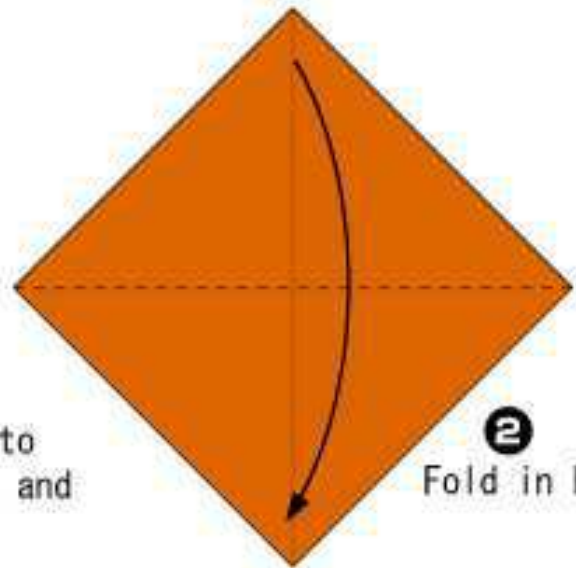

2
Fold in half

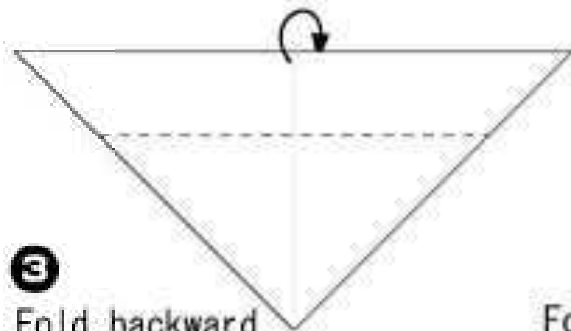

3
Fold backward
in the dotted line

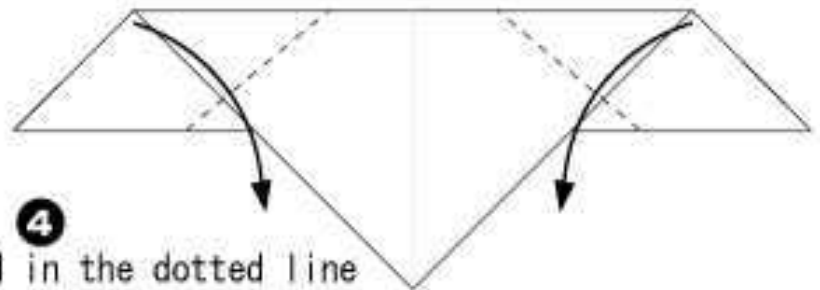

4
Fold in the dotted line

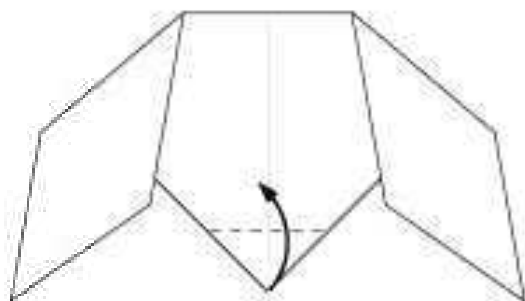

5 Fold in the dotted line

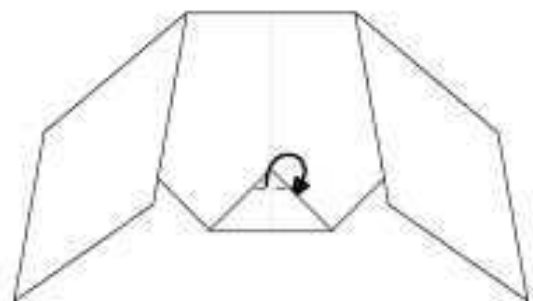

6 Fold inside in the dotted line

7
Draw a face
and finished

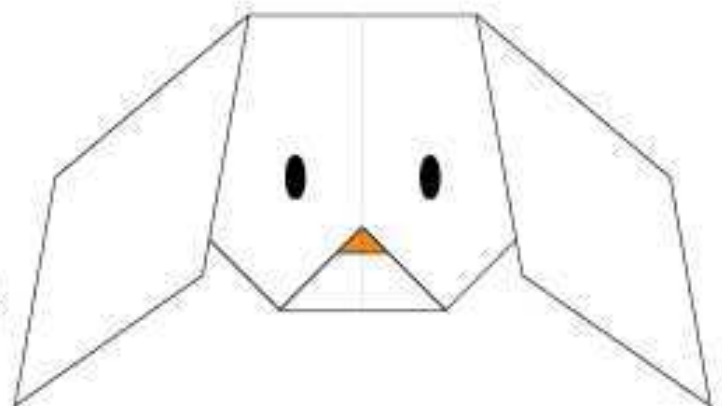

A Poodle Face

